

B17
Washer fluid level sensor for low level

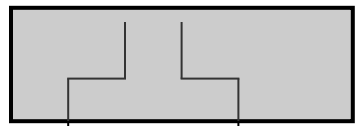

B18
Coolant level sensor

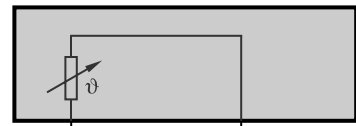

B56
Outside temperature sensor

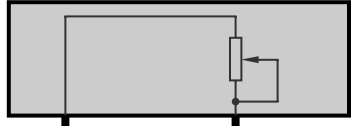

B21
Fuel level sensor

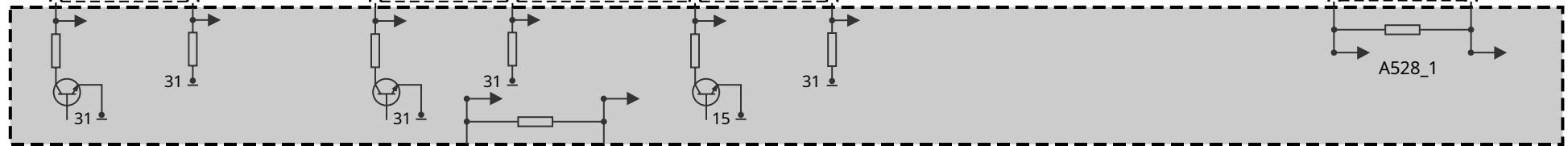
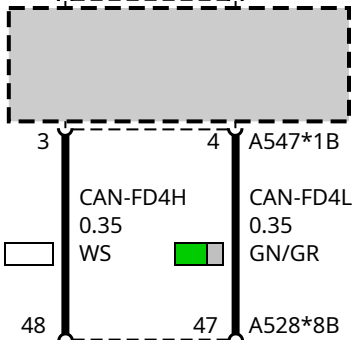
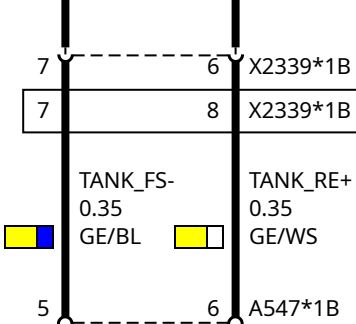
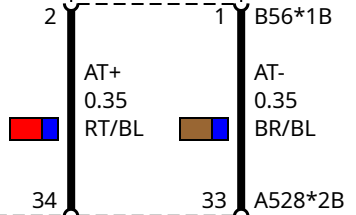
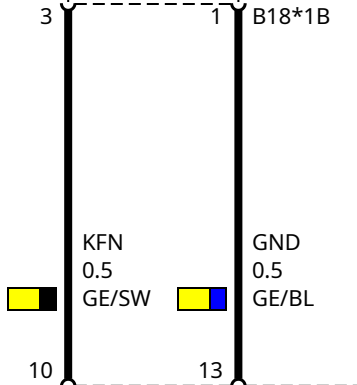
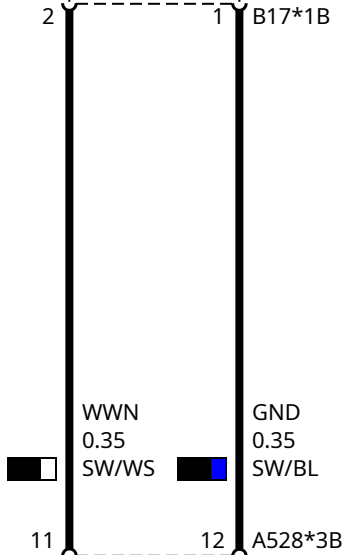

A528
Basic central platform (BCP)

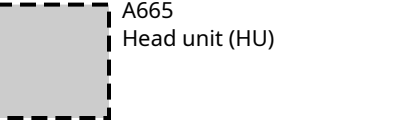
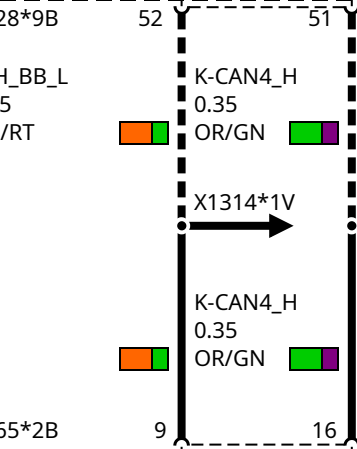
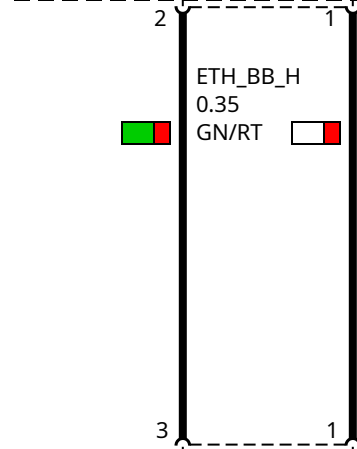

A665
Head unit (HU)

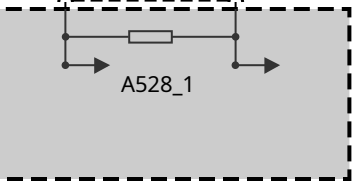

A528
Basic central platform (BCP)